

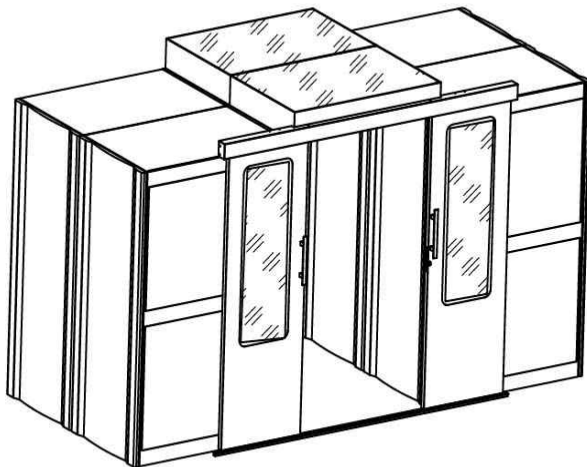

Main Structure



19"

IP20

Loading Capacity
60KGS

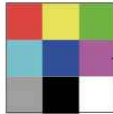

Any color customization



Product Description:

- *One Section/ Single Section Wall Mount Cabinet
- *Can be Disassembled, Flat Packing, Save the Shipping Cost.
- *Standing or wall mounting installation
- *Adjustable feet and heavy duty castors are optional
- *Removable side panels, side locks optional
- *Cable entry on both of top cover and bottom panel
- *120mm fan available (220V or 110V)
- *Turning angle of front door is over 180 degrees.

standard:

Comply with ANSI/EIA RS-310-D, IEC297-2, DIN41494; PART1, DIN41494; PART7, ETSI standard

Material:

High grade cold rolled steel.

Thickness:

Mounting profile: 1.50mm others: 1.2mm

Surface finish:

Degrease, acid pickling, rust prevention and Parkerizing, pure water cleaning, static electricity plastic painting.

Body Color:

RAL7035, RAL7044, RAL9004 etc.

- | NO | Item |
|----|------------------|
| 01 | Top cover |
| 02 | Bottom cover |
| 03 | Frame |
| 04 | Front glass door |
| 05 | Rear door |
| 06 | Side door |
| 07 | Top panel |

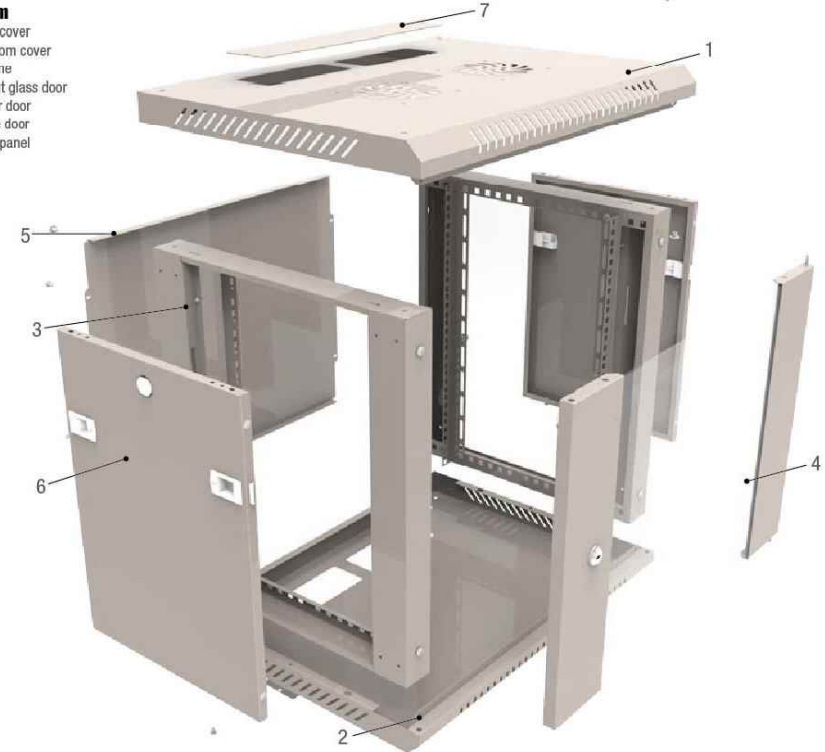

>Accessory Bag Fixed with Rails



>Quick Open Side door, Lock is Optional



>Rail Mounts with "U" Marking, It's Easy to Install the Equipment in Right Height.



>Earth Kit

High Quality & very low cost

Width : 600 mm
Depth : 450 mm or 600 mm
Heights : 4U, 6U, 9U, 12U, 15U, 18U, 22U and 27U



19"

IP20

Loading Capacity
800KGS

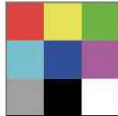

Any color customization

Product Description:

- *Exquisite design with precise dimension and craftsmanship;
- *Toughened temper glass door front and rear solid steel door
- *Lockable door and side panels for system security;
- *Fully adjustable vertical mounting rails ;
- *Swiveling wheels and legs can be jointly installed to withstand up to 800kg maximum static load ;
- *Several lockable wiring holes on top/bottom, size of the large hole at the bottom adjustable;

standard:

Comply with ANSI/EIA RS-310-D, IEC297-2, DIN41494; PART1, DIN41494; PART7, ETSI standard

Material:

High grade cold rolled steel.

Thickness:

Mounting profile: 2.00mm others: 1.2--1.5mm

Surface finish:

Degrease, acid pickling, rust prevention and Parkerizing, pure water cleaning, static electricity plastic painting.

Body Color:

RAL7035, RAL9004 etc.



>Front and Rear Door Bolt, the Doors can be Installed Right or Left Side.



>Connect Bar with Square Holes can be Adjust the Depth with Rail Mounts.



>Top with Fan Tray.
2Pieces for 600mm Depth
4Pieces for 800mm, 1000mm Depth



>High Quality Spring Lock, Easy to Open and Close the Door.

Main Structure

NO Item

- 01 Top Cover
- 02 Bottom Cover
- 03 Frame
- 04 Front Glass Door
- 05 Side Door
- 06 Rear Door
- 07 Connect Bar
- 08 Rail
- 09 Top Panel
- 10 Bottom Panel
- 11 Castor



MULTI-VIEW

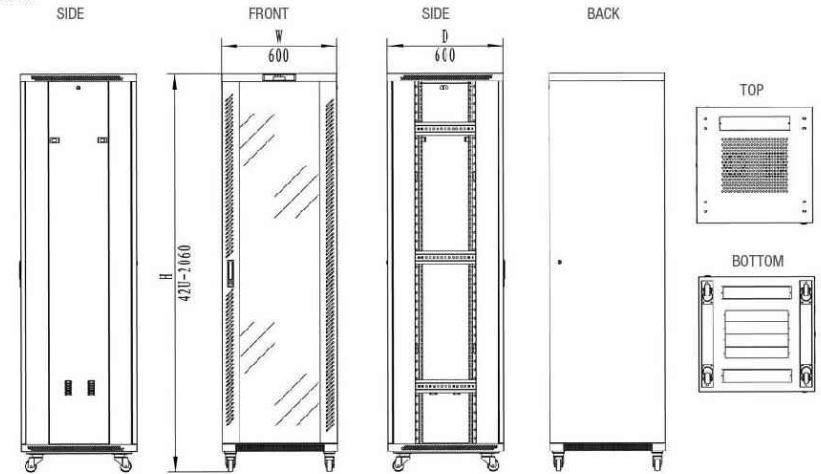

High Quality & very low cost

Width : 600 or 800 mm
Depth : 600 mm, 800mm, 1000 mm and 1200 mm
Heights : 12U, 15U, 18U, 22U, 27U, 32U, 37U, 42U, 45U and 47U

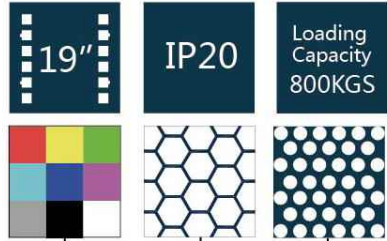

Any color customization

4mm holes Ventilation Rate 65%
 5.5mm holes Ventilation Rate 50%
 6.5mm holes Ventilation Rate 85%
 8mm holes Ventilation Rate 70%

Product Description:

- *Exquisite design with precise dimension and craftsmanship;
- *High-density ARC vented front single & rear dual doors, Lockable door and side panels for system security;
- *Fully adjustable vertical mounting rails ;
- *Swiveling wheels and legs can be jointly installed to withstand up to 800kg maximum static load ;
- *Lockable wiring holes on top/bottom, size of the large hole at the bottom adjustable;

standard:

Comply with ANSI/EIA RS-310-D, IEC297-2, DIN41494; PART1, DIN41494; PART7, ETSI standard

Material:

High grade cold rolled steel.

Thickness:

Mounting profile: 2.00mm others: 1.2--1.5mm

Surface finish:

Degrease, acid pickling, rust prevention and Parkerizing, pure water cleaning, static electricity plastic painting.

Body Color:

RAL7035, RAL9004 etc.

Main Structure

NO Item

- 01 Top Cover
- 02 Fan Tray
- 03 Front ARC Mesh Door
- 04 Rail Mount
- 05 Connect Bar
- 06 Bottom cover
- 07 Wheels
- 08 Adjustable Feet
- 09 Castor Panel
- 10 Side Panel
- 11 Rear Dual Mesh Door

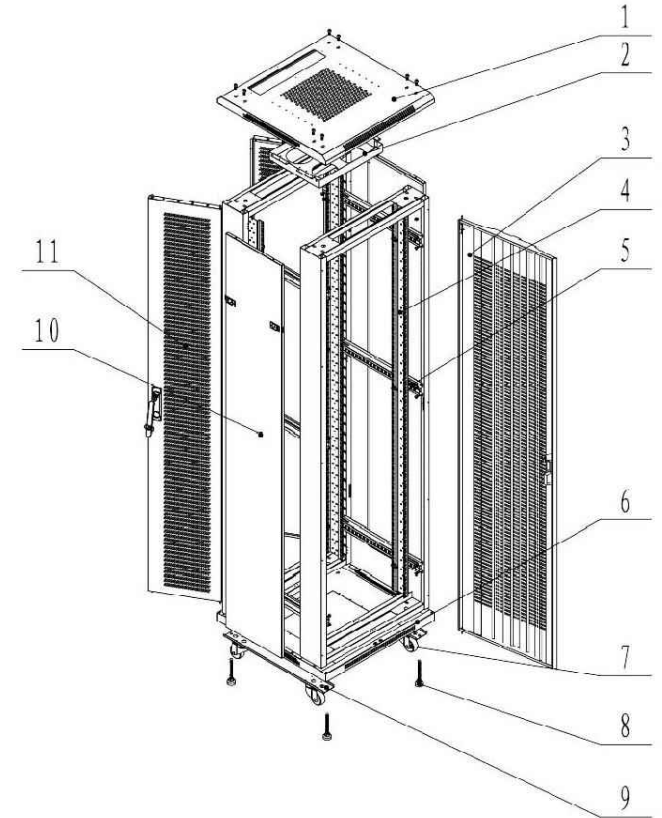

MULTI-VIEW

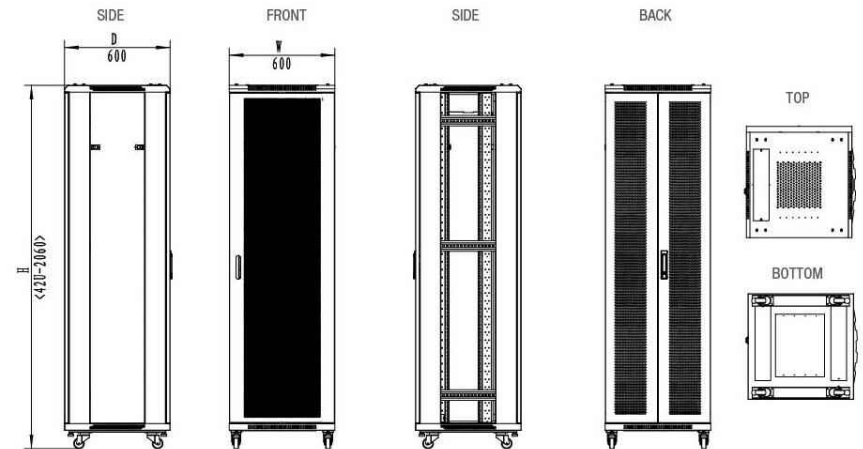

>Front ARC Mesh Door With Exquisite Design.



>Top with Fan Tray.
 2Pieces for 600mm depth
 4Pieces for 800mm,1000mm depth.



>Rail Mounts with "U" Marking, it's easy to install the equipment in right height.



>Accessory Package with Small Carton Box, it's Very Easy to be Found In the Cabinet.

Width : 600 and 800 mm.
 Depth : 600, 800, 1000 and 1200 mm.
 Heights : 12U, 18U, 22U, 27U, 32U, 37U, 42U, 45U and 47U

Hight Quality & very low cost

Kalkenstraat 91- 93 B-8800 ROESLARE (Roulers) Belgium
Tel: 051/25.06.10 Fax: 051/24.02.57 E-mail: edp@eldeco.be Site: www.eldeco-edp.eu

